

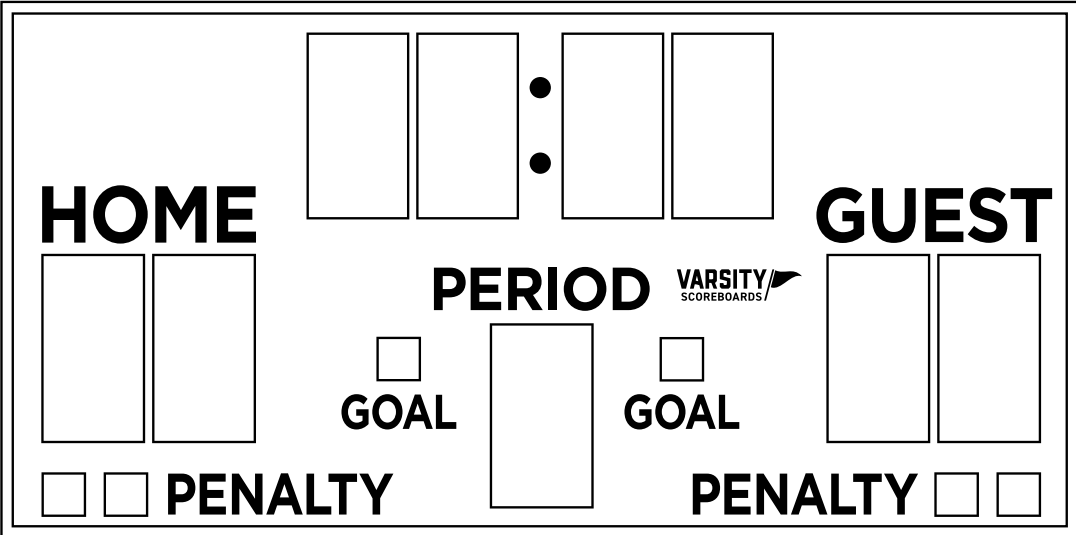

MODEL 1332

Installation Manual





MODEL 1332 INSTALLATION

WARRANTY

This product is warranted against defects in materials and workmanship for the period specified in the warranty from the date of invoice.

SERVICE

Technical Support is available 24 hours a day, 7 days a week.
1-800-411-3136

<https://www.varsityscoreboards.com/support/contact-support.html>
(link to fill out support request on website)



A NOTE TO INSTALLERS

If you are installing this scoreboard for a client, please return the manual to the individual in charge of the scoreboard upon completion of installation.

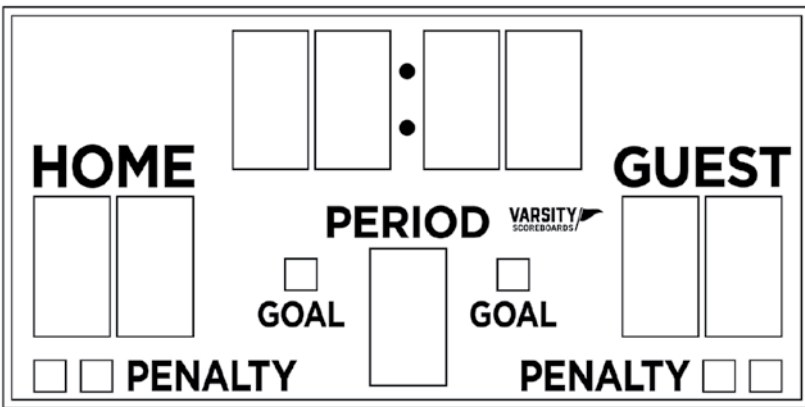

SCOREBOARD DIMENSIONS

8.0' wide x 4.0' tall x 8" depth



TABLE OF CONTENTS

MODEL 1332 INSTALLATION.	5-6
INSTALLATION OVERVIEW.7
PRODUCT SPECIFICATIONS	8
DETERMINING LOCATION AND ORIENTATION	9
INSTALLING MOUNTING POLES OR I-BEAMS10
MOUNTING THE SCOREBOARD	11-12
INSTALLING SPONSOR PANELS	13-14
TESTING INSTALLED SYSTEM.	15



MODEL 1332 INSTALLATION

Please inspect all shipping containers upon arrival for damage and ensure that you have all of the parts listed below:

ITEMS IN LARGE PACKAGE(S)

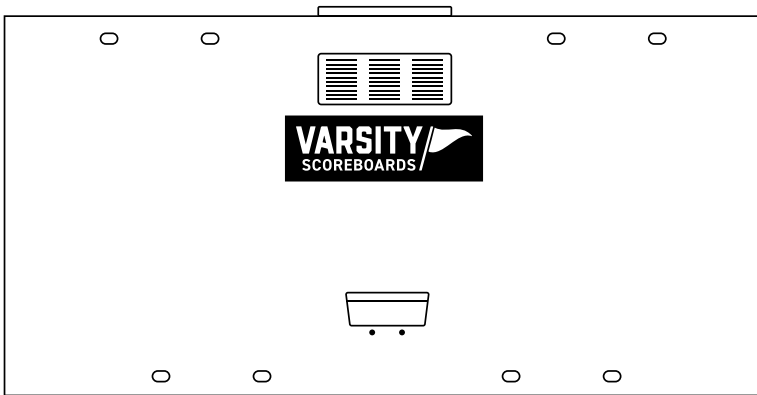

**(1) 8' x 4' Hockey
Scoreboard**

Shipped in (1) section

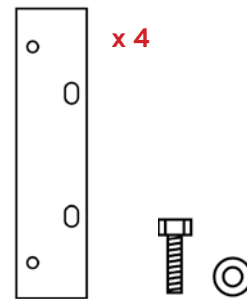

(1) Mounting Tools

Flat Stock Mounting Brackets
and bolts

ITEMS IN ACCESSORY BAG

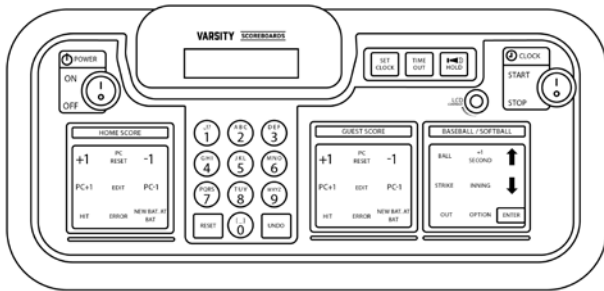

(1) LCD Wireless
Keyboard Controller

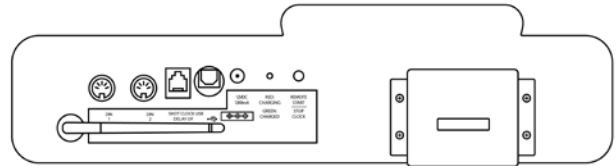

(1) 12-volt adaptor

(1) Sport Inserts

INSTRUCTIONS FOR REPORTING SHIPPING DAMAGE

1 /

Note “DAMAGED” on the Delivery Receipt Form, including details of the type of damage to the freight and packaging.

2 /

Ask the delivery driver to call the local terminal and report immediately.

3 /

Contact Varsity Scoreboards immediately while the delivery driver is still present to report the damage

- A. Phone number
- B. Email

Shipping damage **must** be noted at the time of delivery. The shipper is **not responsible** for shipments that aren’t sighted for as damaged upon arrival. The shipper is responsible for filing a claim, unless shipped 3rd party.



INSTALLATION OVERVIEW

This manual will walk you through the installation of the scoreboard. While care has been taken to consider the many scenarios for installation, some general information applies to all. Follow this guide as closely as possible to ensure proper installation.

1 /

Review the product specifications below to determine your specific installation hardware.

2 /

Determine the scoreboard's location and orientation.

3 /

Install the mounting poles / I Beams.

Note: *I Beams supplied by the customer.*

4 /

Mount the scoreboard to the poles / I Beams.

Note: *Mounting hardware supplied by the customer.*

5 /

Install any options, such as sponsor panels or protective nets, according to the installation instructions included with each option package.

6 /

Test the installed system.



PRODUCT SPECIFICATIONS

OVERALL DIMENSIONS

8' L x 4' W x 8" D - shipped in one (1) section

WEIGHT

Hanging weight = approximately 150 lbs
Shipping weight = approximately 180 lbs

CONSTRUCTION

22-gauge galvanized steel cabinet with powder coat finish for strength, durability, and lasting appearance

INSTALLATION RECOMMENDATIONS

We recommend this model to be installed between (2) 8" steel I-beams (W8 x 13).

Total length determined by local codes, customer preferred mounting height, and scoreboard options. Concrete Footer depth /diameter as well as pole/concrete specifications must be based on customer's local building codes, soil conditions, and wind loads. Flat Stock mounting brackets and bolts are supplied.

Support structure and mounting hardware supplied by installer/others.

POWER REQUIREMENTS

SCOREBOARD

(1) 20-amp, 120-volt, 60-hertz, grounded AC circuit, disconnect switch at the scoreboard is recommended. Specific power requirement information is also marked on the scoreboard's serial number label, located on the scoreboard. Power consumption is 72 watts.

LCD WIRELESS KEYBOARD CONTROLLER

(1) 12-volt adaptor in a standard 120V outlet to charge the controller

NOTE: To maintain the life of the LCD controller, in between games or seasons, store the keyboard in a place where you can keep the adapter plugged in year-round, helping regulate the battery voltage.



DETERMINING LOCATION & ORIENTATION

The scoreboard should be positioned so that the greatest number of spectators can easily view it. Also, consider the best orientation of the scoreboard should the system be used to score a daytime or afternoon game. The scoreboard should be positioned so that sunlight does not glare off its face.

In the U.S., placement on the South or West side of the field is recommended. Consult with the local building or zoning department before final determination and installing the scoreboard.



INSTALLING MOUNTING POLES OR I-BEAMS

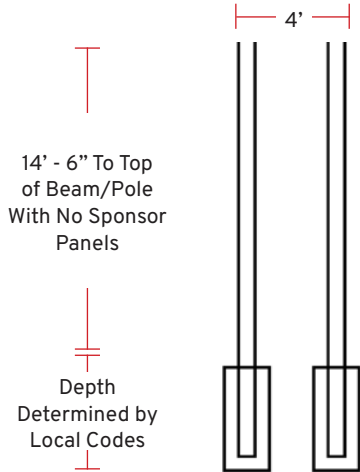

The following information for installing the mounting poles/ beams are suggestions only. Local codes, field placement, scoreboard options, customer preference, and other special considerations will determine the specifics of your installation, including footer specifications, above ground height, and total length of the poles/I-beams.

Consult with local building officials for the required pole sizes and footer construction regarding this installation. A local architect, structural engineer, or sign installer may also be a source of assistance.

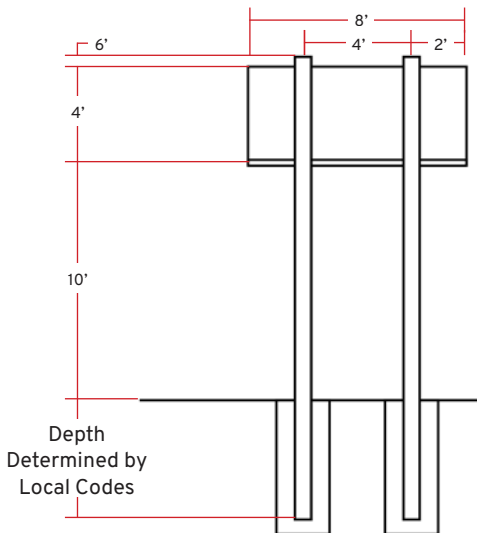

1 /

Install the two (2) mounting poles/I-beams (supplied by the customer) on the field with a recommended column spacing of 4-8' apart and with a recommended 14'-6" of pole/I-beam above ground (refer to the figures below).

Remember: Keep boom and lines away from power lines to avoid shock or electrical burn

2 /

The poles / I-beams must be set into concrete footers. Make sure the poles are level and plumb and spaced on recommended 4' centers. The mounting faces of poles/I-beams must be straight with each other.

NOTE: IF THE POLES/I-BEAMS ARE NOT IN ALIGNMENT – SHIMS MAY BE NEEDED TO MOUNT THE SCOREBOARD PROPERLY. MOUNTING THE SCOREBOARD WITH THE POLES/I-BEAMS OUT OF ALIGNMENT MAY DAMAGE THE SCOREBOARD AND VOID THE WARRANTY.

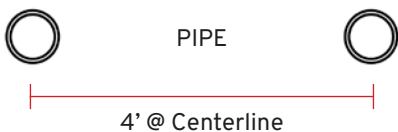
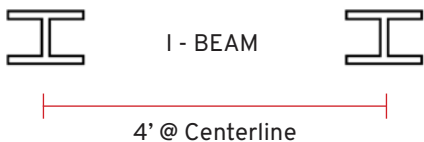

RE-USING OLD COLUMNS

If you plan to re-use old columns to install your scoreboard, please take measurements of your columns and call technical support at 800-411-3136 to discuss further instructions.

NOTE: The location of the disconnect switch after installation shall comply with Article 600 of the National Electric Code.



MOUNTING THE SCOREBOARD

IMPORTANT:

IF YOU DECIDE TO MOUNT THE SCOREBOARD TO A WALL, A MINIMUM OF 12" CLEARANCE MUST BE MAINTAINED FOR ACCESS TO THE POWER ON THE BACK OF THE SCOREBOARD CABINET.

NOTE: Choosing to mount the scoreboard to a wall may make servicing the scoreboard more difficult

1 /

Using provided hardware, bolt the flat stock mounting brackets to the inside back U-channel on the scoreboard.

2 /

Using the lift holes provided in the flat stock mounting brackets, connect a lift device to the scoreboard. Lift the scoreboard into place to the desired height, ensuring that the scoreboard is level.

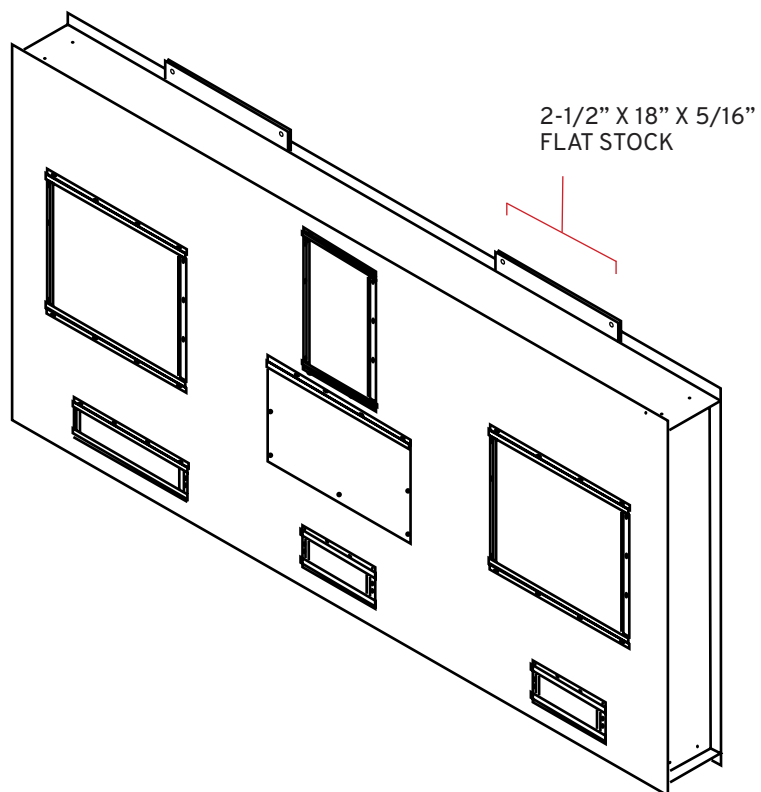

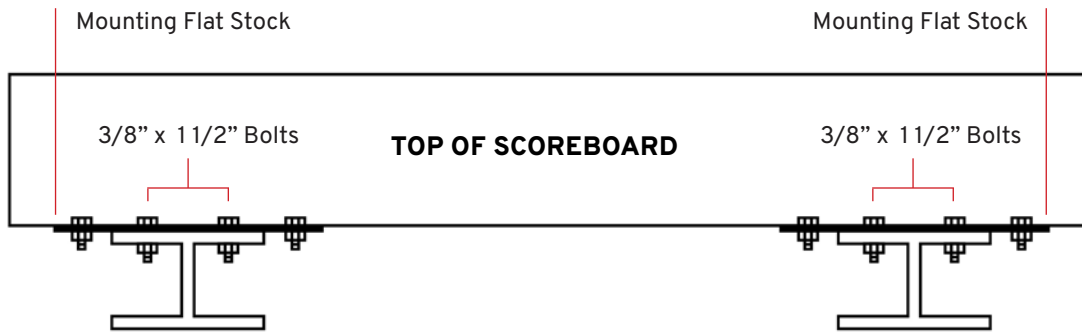
**3 /**

Secure the scoreboard to the beams using the flat stock mounting brackets attached to the scoreboard. The unit must be attached to each beam on top *and* bottom.

4 /

If using steel I-beams, either weld the mounting flanges to the supports, or drill the mounting flanges and supports to use bolts, washers, and nuts to secure the scoreboard to the I-beams. Refer to the figure for detailed illustrations of this mounting method.

5 /

If a sponsor panel was purchased, refer to page 13 for install instructions. If any other options were purchased, refer to their specific installation instructions.



INSTALLING SPONSOR PANELS

NOTE:

DETERMINE NUMBER OF SPONSOR PANELS
BEING INSTALLED AND THEIR LOCATION.

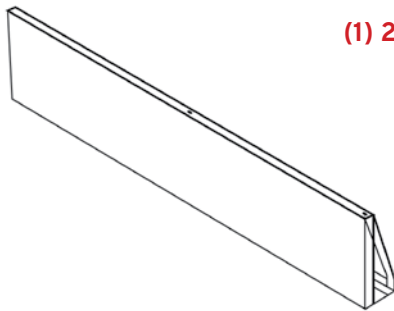

(1) 21" x 8' Panel



(3) Mounting Brackets



(6) 3/8-16 x 3/4" Bolts



(6) 3/8-16 Hex Nuts



(9) #8 x 1/2" Self Tap
Screws



(12) M3/8" Flat Washers

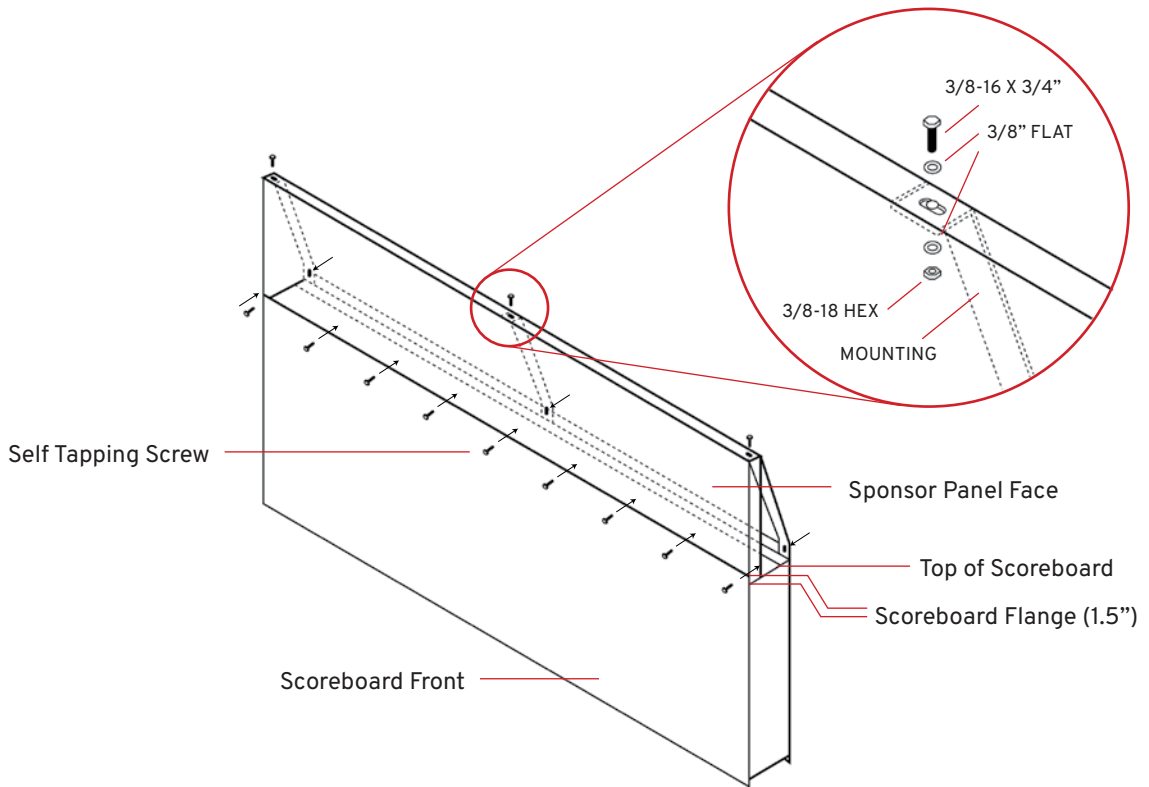

1 /

Before the sponsor panel is lifted into place, attach the mounting brackets to the edge that will be away from the scoreboard, using the supplied hardware. Each panel is pre-drilled for the hardware. The brackets fit inside the flange of the panel.

NOTE: To avoid damaging the finish on the sponsor panel, a flat washer should be used under each bolt and nut (See Figure 1).

2 /

Lift the sponsor panel into place with the panel resting on top of the scoreboard for top-mounted installations or against the bottom of the scoreboard for bottom-mounted installations. The face of the panel should be flat against the scoreboard's front flange (See Figure 1).

3 /

Using the supplied hardware attach the mounting brackets to the scoreboard's back flange (See Figure 1).

4 /

Install self tap screws through the scoreboard's front flange and into the sponsor panel face, spaced evenly.

NOTE: To avoid damaging border striping please drill approximately 1 inch from the edge of scoreboard's flange.



TESTING THE INSTALLED SYSTEM

Please refer to the OPERATORS MANUAL for startup instructions.

AFTER INSTALLATION IS COMPLETE, HAVE THE INSTALLER TEST THE SCOREBOARD BY FOLLOWING THE STEPS BELOW:

1 /

While holding down the OPTIONS button, turn the wireless controller on

2 /

The screen will display "Select Diag Mode." Press the down arrow once to scroll to "Digit Test." Press ENTER.

3 /

The screen will display "Segment Test" and "Segments Off". Press the down arrow once to display "Segments On". When all segments are on, all digits should display "8"

4 /

Press the down arrow again to display "Digits Count". All digits should continuously count from 0-9

5 /

If all digits turn on and count, the installer can then turn off the wireless controller.

Congratulations!

You've successfully installed your Varsity Scoreboard!

If any problems arise, please have the installer call Varsity Scoreboards Customer Service at 800-411-3136 while the installer is still present at the scoreboard.

VARSIITY / 
SCOREBOARDS /