

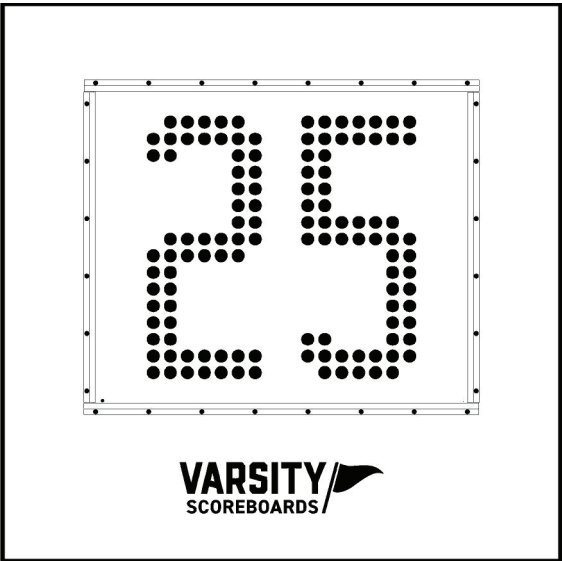

# MODEL 3532

Installation Manual



# MODEL 3532 INSTALLATION /

## WARRANTY

This product is warranted against defects in materials and workmanship for the period specified in the warranty from the date of invoice.

## SERVICE

Technical Support is available 24 hours a day, 7 days a week.  
1-800-411-3136

<https://www.varsityscoreboards.com/support/contact-support.html>  
(link to fill out support request on website)

# A NOTE TO INSTALLERS /

If you are installing this pitch clock for a client, please return the manual to the individual in charge of the timer upon completion of installation.

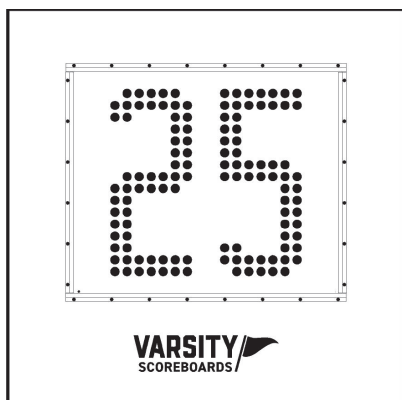

## **DIMENSIONS**

4' tall x 4' wide x 8" depth

# TABLE OF CONTENTS /

- MODEL 3532 INSTALLATION . . . . . 6-7
- INSTALLATION OVERVIEW . . . . . 8
- PRODUCT SPECIFICATIONS . . . . . 9
- DETERMINING LOCATION AND ORIENTATION . . . . . 10
- INSTALLING MOUNTING POLES OR I-BEAMS. . . . . 11
- MOUNTING THE CLOCKS. . . . . 12
- TESTING INSTALLED SYSTEM . . . . . 13



## MODEL 3532 INSTALLATION

Please inspect all shipping containers upon arrival for damage and ensure that you have all of the parts listed below:

### ITEMS IN LARGE PACKAGE(S)

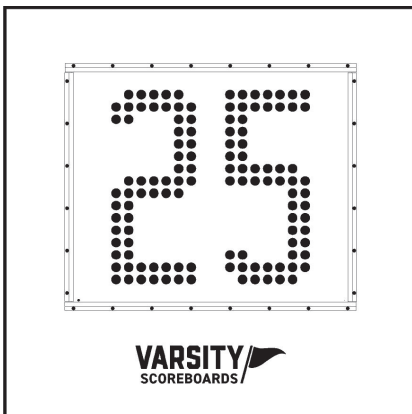

#### (1) 3' x 3' Pitch Clock

Shipped in (1) one section

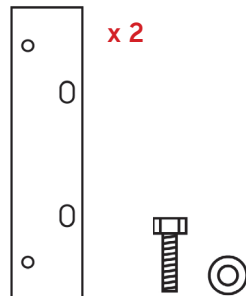

#### Mounting Tools

Flat Stock Mounting  
Brackets & bolts

## ITEMS IN ACCESSORY BAG

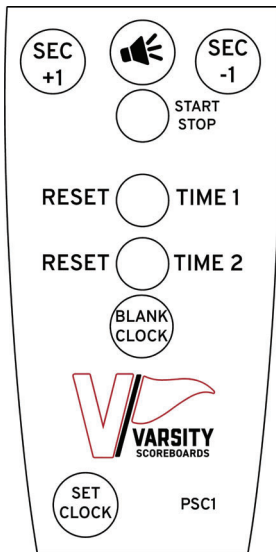

(1) PSC1 Controller

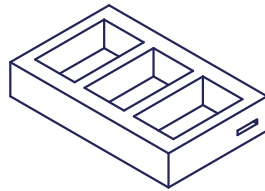

(1) Battery Charging  
Dock

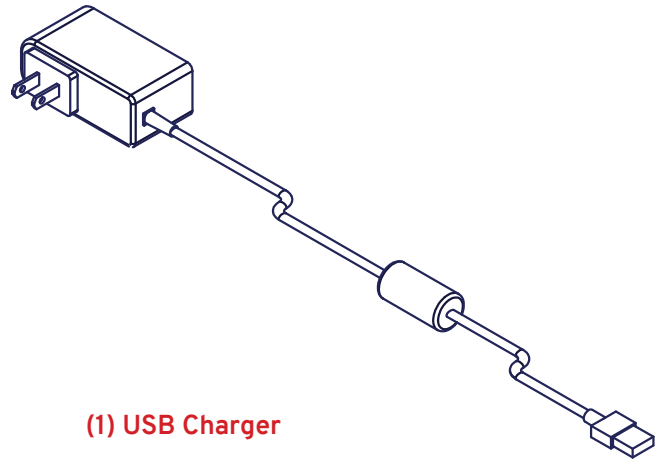

(1) USB Charger

## INSTRUCTIONS FOR REPORTING SHIPPING DAMAGE

### 1 /

Note "DAMAGED" on the Delivery Receipt Form, including details of the type of damage to the freight and packaging.

### 2 /

Ask the delivery driver to call the local terminal and report immediately.

### 3 /

Contact Varsity Scoreboards immediately while the delivery driver is still present to report the damage

- A. Phone number
- B. Email

Shipping damage **must** be noted at the time of delivery. The shipper is **not responsible** for shipments that aren't sighted for as damaged upon arrival. The shipper is responsible for filing a claim, unless shipped 3rd party.



## INSTALLATION OVERVIEW

This manual will walk you through the installation of the pitch clock. While care has been taken to consider the many scenarios for installation, some general information applies to all. Follow this guide as closely as possible to ensure proper installation.

### 1 /

Review the product specifications below to determine your specific installation hardware.

### 2 /

Determine the pitch clock location and orientation.

### 3 /

Install the mounting poles / I Beams.

**Note:** *I Beams supplied by the customer.*

### 4 /

Mount the pitch clock to the poles / I Beams.

**Note:** *Mounting hardware supplied by the customer.*

### 5 /

Test the installed system.



## PRODUCT SPECIFICATIONS

### OVERALL DIMENSIONS

4' L x 4' W x 8" D - shipped in one (1) section

### WEIGHT

Hanging weight = approximately 68 lbs  
Shipping weight = approximately 110 lbs

### CONSTRUCTION

22-gauge galvanized steel cabinet with powder coat finish for strength, durability, and lasting appearance

### INSTALLATION RECOMMENDATIONS

We recommend this model to be installed between (2) 8" steel I-beams (W8 x 13).

Total length determined by local codes, customer preferred mounting height, and scoreboard options. Concrete Footer depth /diameter as well as pole/concrete specifications must be based on customer's local building codes, soil conditions, and wind loads. Flat Stock mounting brackets and bolts are supplied.

*Support structure and mounting hardware supplied by installer/others.*

### POWER REQUIREMENTS

#### **PITCH CLOCK**

(1) 20-amp, 120-volt, 60-hertz, grounded AC circuit, disconnect switch at the scoreboard is recommended. Power consumption is 72 watts.

#### **PSC1 WIRELESS CONTROLLER**

(1) 12-volt adapter in a standard 120V outlet to charge the internal and extra batteries.

NOTE: To charge the internal rechargeable 9v battery, turn the PSC1 controller OFF, remove the battery and place it on the provided battery charger. ALWAYS keep the extra batteries charged.





## DETERMINING LOCATION & ORIENTATION

The pitch clock should be positioned so that the greatest number of spectators can easily view it. Also, consider the best orientation of the pitch clock should the system be used to score a daytime or afternoon game. The pitch clock should be positioned so that sunlight does not glare off its face.

In the U.S., placement on the South or West side of the field is recommended. Consult with the local building or zoning department before final determination and installing the pitch clock.



## INSTALLING MOUNTING POLES OR I-BEAMS

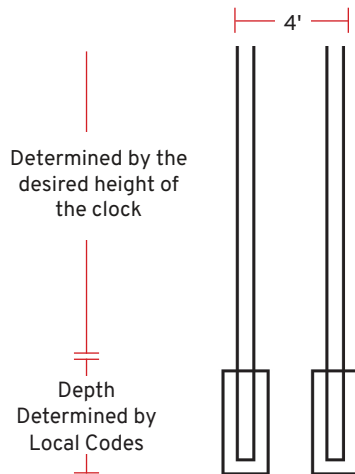

The following information for installing the mounting poles/beams are suggestions only. Local codes, field placement, customer preference, and other special considerations will determine the specifics of your installation, including footer specifications, above ground height, and total length of the poles/I-beams.

Consult with local building officials for the required pole sizes and footer construction regarding this installation. A local architect, structural engineer, or sign installer may also be a source of assistance.

### 1 /

Install the two (2) mounting poles/I-beams (supplied by the customer) on the field with a recommended column spacing of 4' edge to edge.

**Remember: Keep boom and lines away from power lines to avoid shock or electrical burn**

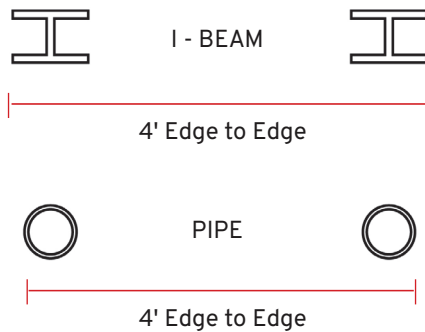

### 2 /

The poles / I-beams must be set into concrete footers. Make sure the poles are level and plumb and spaced on recommended 4' edge to edge. The mounting faces of poles/I-beams must be straight with each other.

NOTE: IF THE POLES/I-BEAMS ARE NOT IN ALIGNMENT – SHIMS MAY BE NEEDED TO MOUNT THE PITCH CLOCK PROPERLY. MOUNTING THE PITCH CLOCK WITH THE POLES/I-BEAMS OUT OF ALIGNMENT MAY DAMAGE THE PITCH CLOCK AND VOID THE WARRANTY.

### RE-USING OLD COLUMNS

If you plan to re-use old columns to install your pitch clock, please take measurements of your columns and call technical support at 800-411-3136 to discuss further instructions.

**NOTE: The location of the disconnect switch after installation shall comply with Article 600 of the National Electric Code.**



## MOUNTING THE CLOCK

### IMPORTANT:

IF YOU DECIDE TO MOUNT THE PITCH CLOCK TO A WALL, A MINIMUM OF 12" CLEARANCE MUST BE MAINTAINED FOR VENTING OF THE PITCH CLOCK.

#### 1 /

Carefully remove the clock from its packaging, making sure to not pry against or cut into the pitch clock.

#### 2 /

Attach the 4' mounting brackets to the pitch clock using the provided 3/8" hardware.

#### 3 /

Connect a lift device to the top mounting brackets in two (2) locations that will not interfere with the mounting poles/beams.

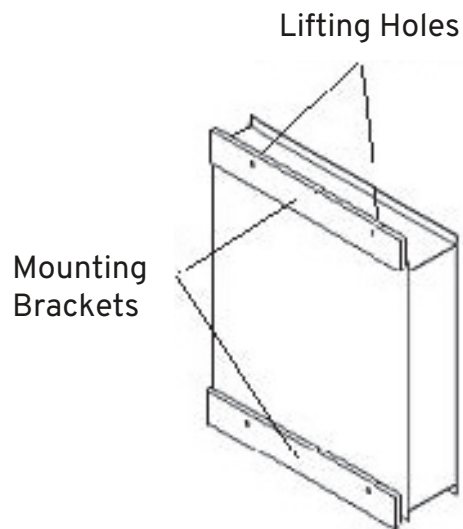

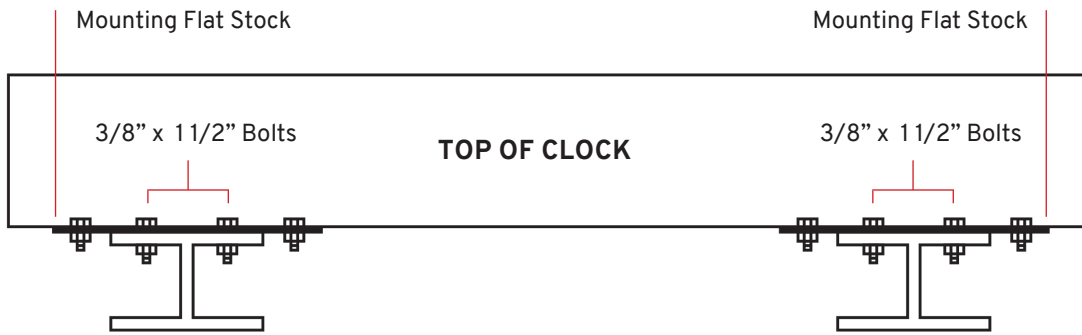

**4 /**

Lift the clock into place, ensuring that it is level.

**5 /**

Secure the pitch clock to the poles/beams using the mounting brackets that are now attached to the timer. The units must be attached to each pole or beam on top and on bottom. If using steel I-beams, the mounting brackets may be welded to the beams so that a combination of bolts, washers, and nuts may be used to secure the mounting brackets to the I-beams. Refer to the diagram above for detailed instructions.



## TESTING THE INSTALLED SYSTEM

Please refer to the OPERATORS MANUAL for startup instructions.

**Congratulations!**

**You've successfully installed your  
Varsity Pitch Clock!**

If any problems arise, please have the installer call Varsity Scoreboards Customer Service at 800-411-3136 while the installer is still present at the pitch clock.

**VARSDTY** /   
**SCOREBOARDS** /