

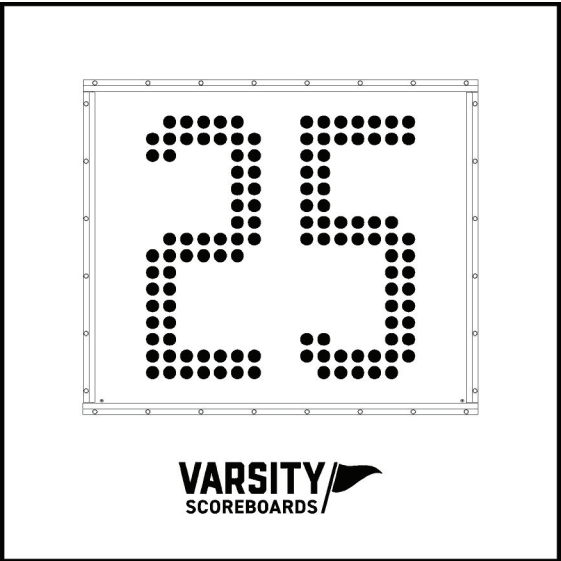

MODEL 7400

Installation Manual

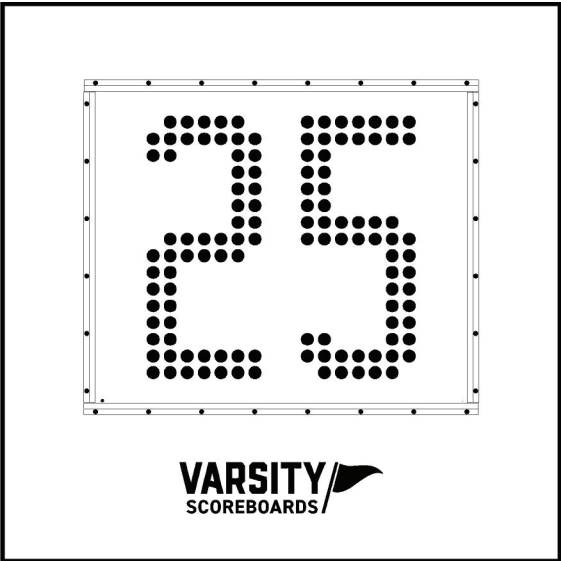

MODEL 7400 INSTALLATION /

WARRANTY

This product is warranted against defects in materials and workmanship for the period specified in the warranty from the date of invoice.

SERVICE

Technical Support is available 24 hours a day, 7 days a week.
1-800-411-3136

<https://www.varsityscoreboards.com/support/contact-support.html>
(link to fill out support request on website)

A NOTE TO INSTALLERS /

If you are installing these delay-of-game clocks for a client, please return the manual to the individual in charge of the clocks upon completion of installation.

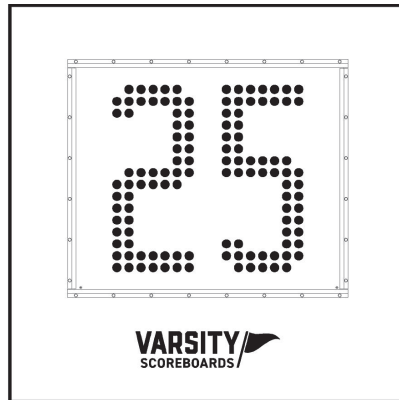
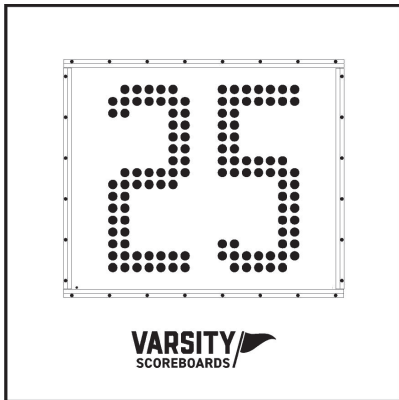

DIMENSIONS

4.0' tall x 4.0' wide x 8" depth

TABLE OF CONTENTS /

- MODEL 7400 INSTALLATION. 6-7
- INSTALLATION OVERVIEW8
- PRODUCT SPECIFICATIONS9
- DETERMINING LOCATION AND ORIENTATION 10-18
- INSTALLING MOUNTING POLES OR I-BEAMS. 10-18
- MOUNTING THE CLOCKS..... 10-18
- TESTING INSTALLED SYSTEM 10-18



MODEL 7400 INSTALLATION

Please inspect all shipping containers upon arrival for damage and ensure that you have all of the parts listed below:

ITEMS IN LARGE PACKAGE(S)

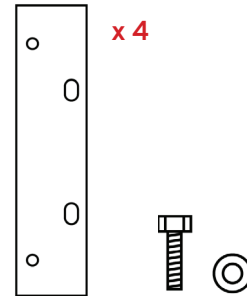
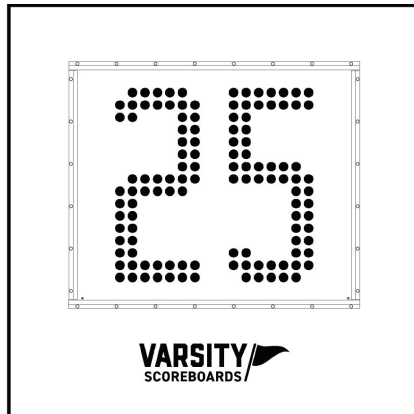
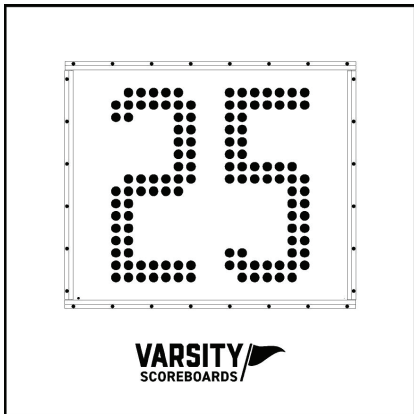

(2) 4' x 4' Delay-of-Game Clocks

Shipped in (1) one section

(1) Mounting Tools

Flat Stock Mounting
Brackets & bolts

ITEMS IN ACCESSORY BAG

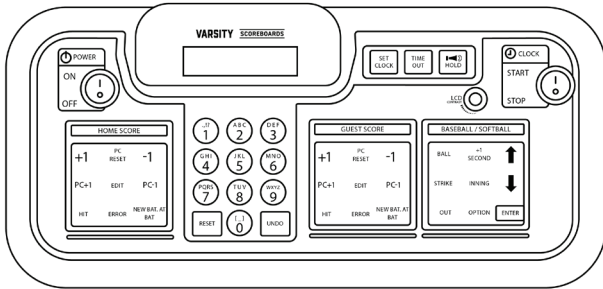

(1) LCD Wireless
Keyboard Controller

(1) Sport Inserts

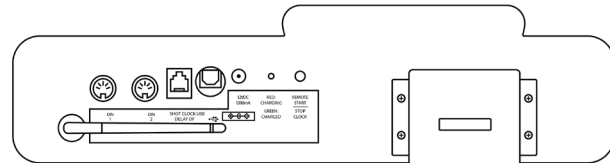

(1) 12-volt adaptor

(1) Hand-held clock
switch



INSTRUCTIONS FOR REPORTING SHIPPING DAMAGE

1 /

Note "DAMAGED" on the Delivery Receipt Form, including details of the type of damage to the freight and packaging.

2 /

Ask the delivery driver to call the local terminal and report immediately.

3 /

Contact Varsity Scoreboards immediately while the delivery driver is still present to report the damage

- A. Phone number
- B. Email

Shipping damage **must** be noted at the time of delivery. The shipper is **not responsible** for shipments that aren't sighted for as damaged upon arrival. The shipper is responsible for filing a claim, unless shipped 3rd party.



INSTALLATION OVERVIEW

This manual will walk you through the installation of the delay-of-game clocks. While care has been taken to consider the many scenarios for installation, some general information applies to all. Follow this guide as closely as possible to ensure proper installation.

1 /

Review the product specifications below to determine your specific installation hardware.

2 /

Determine the delay-of-game clocks location and orientation.

3 /

Install the mounting poles / I Beams.

Note: *I Beams supplied by the customer.*

4 /

Mount the delay-of-game clocks to the poles / I Beams.

Note: *Mounting hardware supplied by the customer.*

5 /

Test the installed system.



PRODUCT SPECIFICATIONS

OVERALL DIMENSIONS

4' L x 4' W x 8" D - shipped in one (1) section

WEIGHT

Hanging weight = approximately 90 lbs per clock
Shipping weight = approximately 125 lbs per clock

CONSTRUCTION

22-gauge galvanized steel cabinet with powder coat finish for strength, durability, and lasting appearance

INSTALLATION RECOMMENDATIONS

We recommend this model to be installed between (2) 8" steel I-beams (W8 x 13) per clock.

Total length determined by local codes, customer preferred mounting height, and scoreboard options. Concrete Footer depth /diameter as well as pole/concrete specifications must be based on customer's local building codes, soil conditions, and wind loads. Flat Stock mounting brackets and bolts are supplied.

Support structure and mounting hardware supplied by installer/others.

POWER REQUIREMENTS

DELAY-OF-GAME CLOCKS

(1) 20-amp, 120-volt, 60-hertz, grounded AC circuit, disconnect switch at the scoreboard is recommended. Power consumption is 72 watts.

LCD WIRELESS KEYBOARD CONTROLLER

(1) 12-volt adaptor in a standard 120V outlet to charge the controller

NOTE: To maintain the life of the LCD controller, in between games or seasons, store the keyboard in a place where you can keep the adapter plugged in year-round, helping regulate the battery voltage.

PSC1 WIRELESS CONTROLLER (OPTIONAL)

(1) 12-volt adaptor in a standard 120V outlet to charge the internal and extra batteries.

NOTE: To charge the internal rechargeable 9v battery, turn the PSC1 controller OFF, remove the battery and place it on the provided battery charger. ALWAYS keep the extra batteries charged.



DETERMINING LOCATION & ORIENTATION

The delay-of-game clock should be positioned so that the greatest number of spectators can easily view it. Also, consider the best orientation of the delay-of-game clocks should the system be used to score a daytime or afternoon game. The delay-of-game clocks should be positioned so that sunlight does not glare off its face.

In the U.S., placement on the South or West side of the field is recommended. Consult with the local building or zoning department before final determination and installing the scoreboard.



INSTALLING MOUNTING POLES OR I-BEAMS

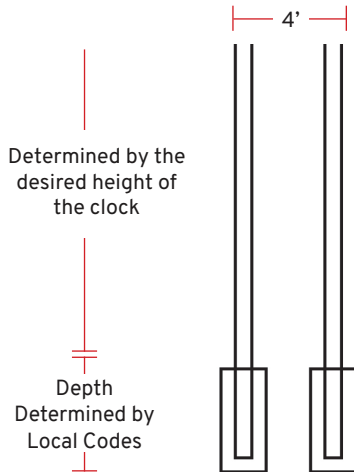

The following information for installing the mounting poles/ beams are suggestions only. Local codes, field placement, customer preference, and other special considerations will determine the specifics of your installation, including footer specifications, above ground height, and total length of the poles/I-beams.

Consult with local building officials for the required pole sizes and footer construction regarding this installation. A local architect, structural engineer, or sign installer may also be a source of assistance.

1 /

Install the two (2) mounting poles/I-beams (supplied by the customer) on the field with a recommended column spacing of 4' edge to edge.

Remember: Keep boom and lines away from power lines to avoid shock or electrical burn

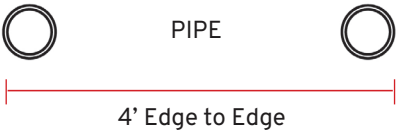
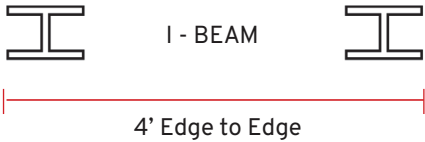

2 /

The poles / I-beams must be set into concrete footers. Make sure the poles are level and plumb and spaced on recommended 4' edge to edge. The mounting faces of poles/I-beams must be straight with each other.

NOTE: IF THE POLES/I-BEAMS ARE NOT IN ALIGNMENT – SHIMS MAY BE NEEDED TO MOUNT THE DELAY-OF-GAME CLOCKS PROPERLY. MOUNTING THE SCOREBOARD WITH THE POLES/I-BEAMS OUT OF ALIGNMENT MAY DAMAGE THE SCOREBOARD AND VOID THE WARRANTY.

RE-USING OLD COLUMNS

If you plan to re-use old columns to install your delay-of-game clocks, please take measurements of your columns and call technical support at 800-411-3136 to discuss further instructions.

NOTE: The location of the disconnect switch after installation shall comply with Article 600 of the National Electric Code.



MOUNTING THE CLOCKS

IMPORTANT:

IF YOU DECIDE TO MOUNT THE DELAY-OF-GAME CLOCKS TO A WALL, A MINIMUM OF 12" CLEARANCE MUST BE MAINTAINED FOR VENTING OF THE DELAY-OF-GAME CLOCKS.

NOTE: IF YOU PURCHASED ROLLING LEG ASSEMBLY, REFER TO PAGE 13 FOR INSTALLATION INSTRUCTIONS.

1 /

Carefully remove each clock from its packaging, making sure to not pry against or cut into the delay-of-game clocks.

2 /

Attach the 4' mounting brackets to the delay-of-game clocks using the provided 3/8" hardware.

3 /

Connect a lift device to the top mounting brackets in two (2) locations that will not interfere with the mounting poles/beams.

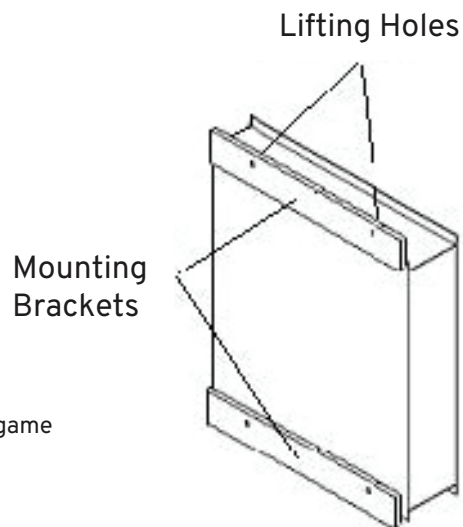

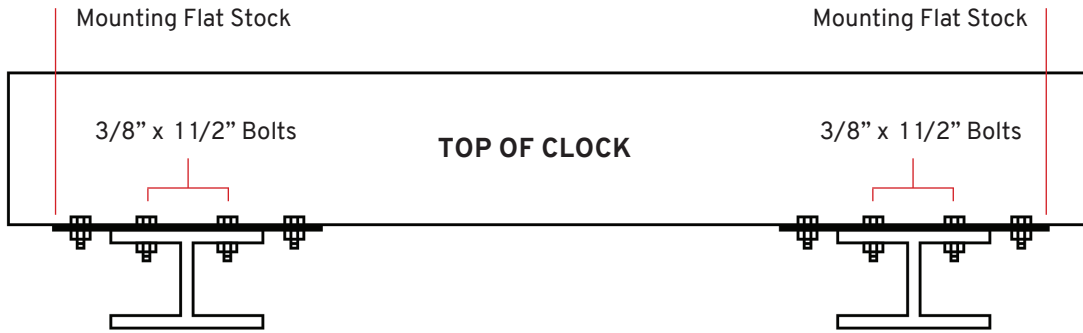

4 /
Lift the clock into place, ensuring that it is level.

5 /
Secure the delay-of-game clocks to the poles/beams using the mounting brackets that are now attached to the clocks. The units must be attached to each pole or beam on top and on bottom. If using steel I-beams, the mounting brackets may be welded to the beams so that a combination of bolts, washers, and nuts may be used to secure the mounting brackets to the I-beams. Refer to the diagram above for detailed instructions.

INSTALLING ROLLING LEGS

LEG ASSEMBLY PARTS

- 1- HANDLE
- 2- LEGS
- 2- 1/4" BOLT (FOR HANDLE)
- 2- 1/4" LOCK WASHERS (FOR HANDLES)
- 4- 1/2" FLAT WASHERS (FOR WHEELS)
- 4- BOLTS, 3/8-16 X 2-1/2 ZINC (FOR LEG ATTACHMENT)
- 4- 3/8" SPLIT LOCK WASHERS (FOR LEG ATTACHMENT)
- 4- 10" WHEELS
- 4- 1/2-13 X 3" BOLT (FOR WHEELS)

1 /
Attach the 10" wheels to the leg that has the factory installed threaded wheel inserts. Use the provided 1/2" hardware to do so. See image below.

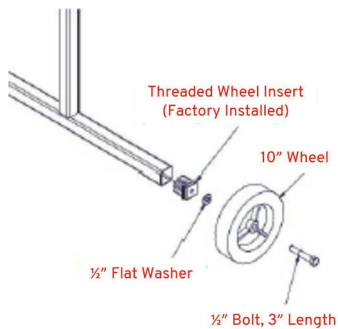

2 /
Attach the legs to the delay-of-game clock cabinet using the provided 3/8" hardware.

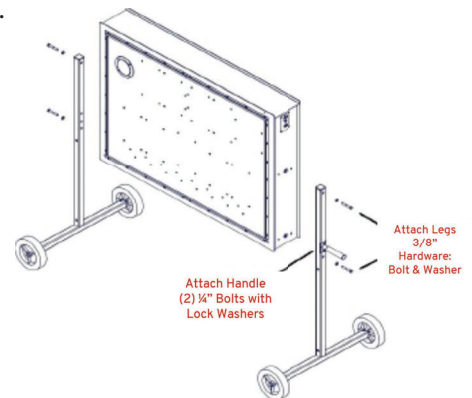



INSTALLING THE HAND-HELD CLOCK SWITCH



Connect the RS-232 jack to the port on the back of the LCD keyboard controller. See image below.

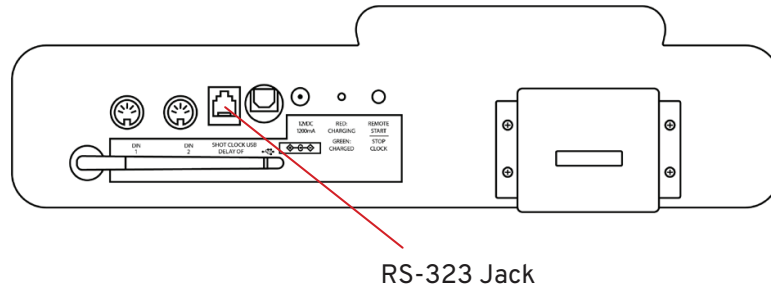

RS-323 Jack



TESTING THE INSTALLED SYSTEM

Please refer to the OPERATORS MANUAL for startup instructions.

AFTER INSTALLATION IS COMPLETE, HAVE THE INSTALLER TEST THE DELAY-OF-GAME CLOCKS BY FOLLOWING THE STEPS BELOW:

1 /

While holding down the OPTIONS button, turn the wireless controller on

2 /

The screen will display "Select Diag Mode." Press the down arrow once to scroll to "Digit Test." Press ENTER.

3 /

The screen will display "Digit test- all digits off". Press the down arrow once to display "Digit test- all digits on". When all segments are on, all digits should display "8"

If any problems arise, please have the installer call Varsity Scoreboards Customer Service at 800-411-3136 while the installer is still present at the scoreboard.

4 /

Press the down arrow again to display “Digit test- Digits Count”. All digits should continuously count from 0-9

5 /

If all digits turn on and count, the installer can then turn off the wireless controller.

Congratulations!

**You’ve successfully installed your
Varsity Delay-of-Game Clocks!**

VARSDTY / 
SCOREBOARDS /