

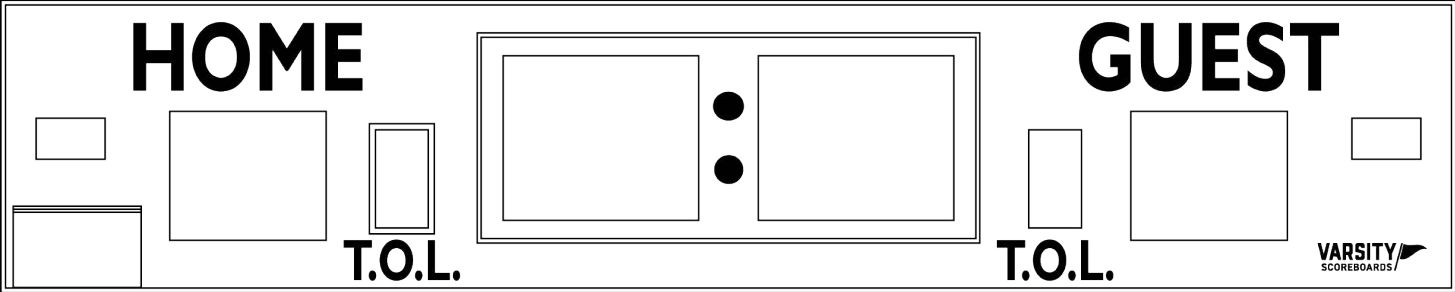

# MODEL 7460

Installation Manual





## **MODEL 7460 INSTALLATION**

### **WARRANTY**

This product is warranted against defects in materials and workmanship for the period specified in the warranty from the date of invoice.

### **SERVICE**

Technical Support is available 24 hours a day, 7 days a week.  
1-800-411-3136

<https://www.varsityscoreboards.com/support/contact-support.html>  
(link to fill out support request on website)



## A NOTE TO INSTALLERS

If you are installing this scoreboard for a client, please return the manual to the individual in charge of the scoreboard upon completion of installation.

### SCOREBOARD DIMENSIONS

20' wide x 4' tall x 8" depth

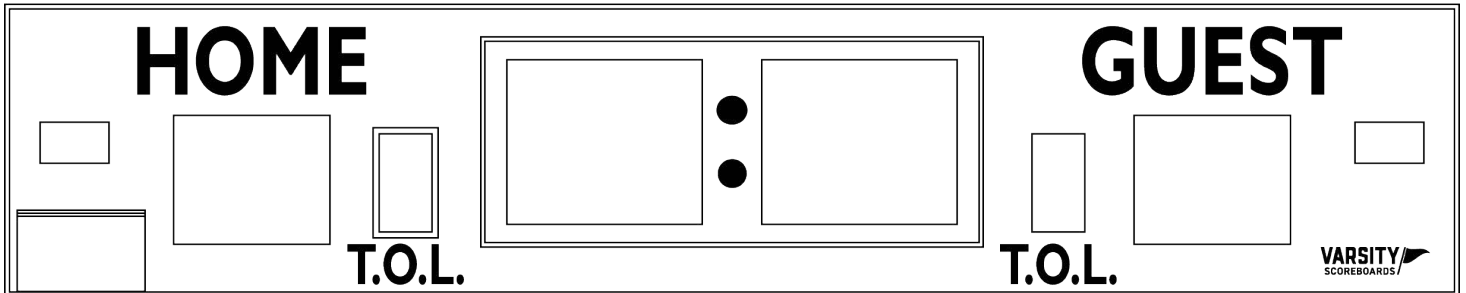



## TABLE OF CONTENTS

MODEL 7460 INSTALLATION . . . . .	5-6
INSTALLATION OVERVIEW . . . . .	7
PRODUCT SPECIFICATIONS . . . . .	8
DETERMINING LOCATION AND ORIENTATION . . . . .	9
INSTALLING MOUNTING POLES OR I-BEAMS . . . . .	10
MOUNTING THE SCOREBOARD . . . . .	11-12
INSTALLING SPONSOR PANELS . . . . .	13-14
TESTING INSTALLED SYSTEM. . . . .	15



# MODEL 7460 INSTALLATION

Please inspect all shipping containers upon arrival for damage and ensure that you have all of the parts listed below:

## ITEMS IN LARGE PACKAGE(S)

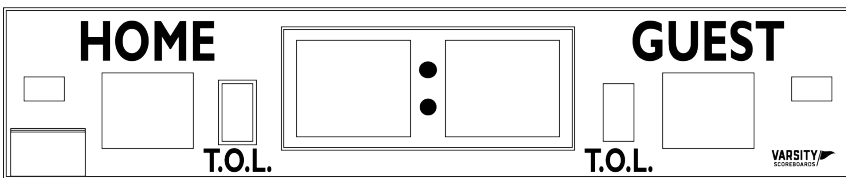

### (1) 20' x 4' Football Scoreboard

Shipped in five (5) sections

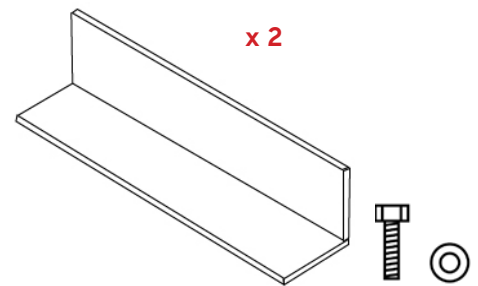

### Mounting Tools

20' mounting angle irons and hardware (nuts, bolts, washers)

## ITEMS IN ACCESSORY BAG

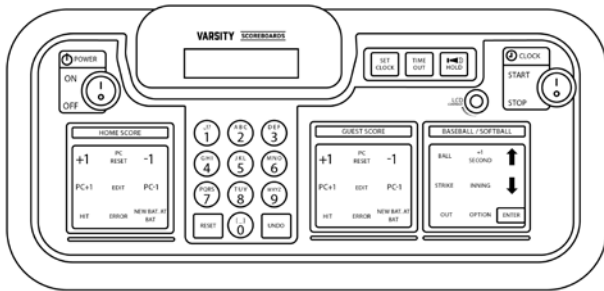

(1) LCD Wireless  
Keyboard Controller

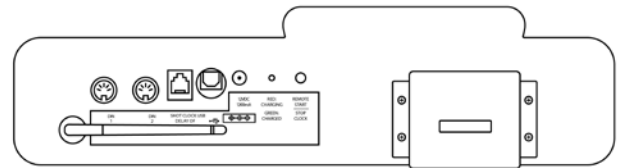

(1) 12-volt adaptor

(1) Sport Inserts

## INSTRUCTIONS FOR REPORTING SHIPPING DAMAGE

### 1 /

Note “DAMAGED” on the Delivery Receipt Form, including details of the type of damage to the freight and packaging.

### 2 /

Ask the delivery driver to call the local terminal and report immediately.

### 3 /

Contact Varsity Scoreboards immediately while the delivery driver is still present to report the damage

- A. Phone number
- B. Email

Shipping damage **must** be noted at the time of delivery. The shipper is **not responsible** for shipments that aren’t sighted for as damaged upon arrival. The shipper is responsible for filing a claim, unless shipped 3rd party.



## INSTALLATION OVERVIEW

This manual will walk you through the installation of the scoreboard. While care has been taken to consider the many scenarios for installation, some general information applies to all. Follow this guide as closely as possible to ensure proper installation.

### 1 /

Review the product specifications below to determine your specific installation hardware.

### 2 /

Determine the scoreboard's location and orientation.

### 3 /

Install the mounting poles / I Beams.

**Note:** *I Beams supplied by the customer.*

### 4 /

Mount the scoreboard to the poles / I Beams.

**Note:** *Mounting hardware supplied by the customer.*

### 5 /

Install any options, such as sponsor panels or protective nets, according to the installation instructions included with each option package.

### 6 /

Test the installed system.



## PRODUCT SPECIFICATIONS

### OVERALL DIMENSIONS

20' L x 4' W x 8" D - shipped in five (5) sections

### WEIGHT

Hanging weight = approximately 550 lbs  
Shipping weight = approximately 688 lbs

## CONSTRUCTION

22-gauge galvanized steel cabinet with powder coat finish for strength, durability, and lasting appearance

## INSTALLATION RECOMMENDATIONS

We recommend this model to be installed between (2) 8" steel I-beams (W8 x 31).

Total length determined by local codes, customer preferred mounting height, and scoreboard options. Concrete Footer depth /diameter as well as pole/concrete specifications must be based on customer's local building codes, soil conditions, and wind loads. Flat Stock mounting brackets and bolts are supplied.

*Support structure and mounting hardware supplied by installer/others.*

## POWER REQUIREMENTS

### SCOREBOARD

(1) 20-amp, 120-volt, 60-hertz, grounded AC circuit, disconnect switch at the scoreboard is recommended. Specific power requirement information is also marked on the scoreboard's serial number label, located on the scoreboard. Power consumption is 144 watts.

### LCD WIRELESS KEYBOARD CONTROLLER

(1) 12-volt adaptor in a standard 120V outlet to charge the controller

**NOTE:** To maintain the life of the LCD controller, in between games or seasons, store the keyboard in a place where you can keep the adapter plugged in year-round, helping regulate the battery voltage.





## DETERMINING LOCATION & ORIENTATION

The scoreboard should be positioned so that the greatest number of spectators can easily view it. Also, consider the best orientation of the scoreboard should the system be used to score a daytime or afternoon game. The scoreboard should be positioned so that sunlight does not glare off its face.

In the U.S., placement on the South or West side of the field is recommended. Consult with the local building or zoning department before final determination and installing the scoreboard.



## INSTALLING MOUNTING POLES OR I-BEAMS

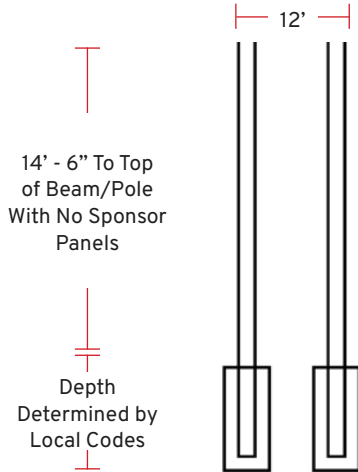

The following information for installing the mounting poles/ beams are suggestions only. Local codes, field placement, scoreboard options, customer preference, and other special considerations will determine the specifics of your installation, including footer specifications, above ground height, and total length of the poles/I-beams.

Consult with local building officials for the required pole sizes and footer construction regarding this installation. A local architect, structural engineer, or sign installer may also be a source of assistance.

### 1 /

Install the two (2) mounting poles/beams (supplied by the customer) on the field 12'-0" (eleven feet, eight inches) center to center with 14'-6"(\*) of pole/beam above ground (refer to the installation diagram below). If a sponsor panel is to be mounted above the scoreboard, leave 21'-0" (\*) of pole/beam above ground (an additional 31").

**Remember: Keep boom and lines away from power lines to avoid shock or electrical burn**

### 2 /

The poles / I-beams must be set into concrete footers. Make sure the poles are level and plumb and spaced on recommended 12' centers. The mounting faces of poles/I-beams must be straight with each other.

NOTE: IF THE POLES/I-BEAMS ARE NOT IN ALIGNMENT – SHIMS MAY BE NEEDED TO MOUNT THE SCOREBOARD PROPERLY. MOUNTING THE SCOREBOARD WITH THE POLES/I-BEAMS OUT OF ALIGNMENT MAY DAMAGE THE SCOREBOARD AND VOID THE WARRANTY.

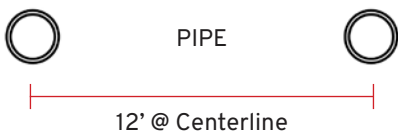
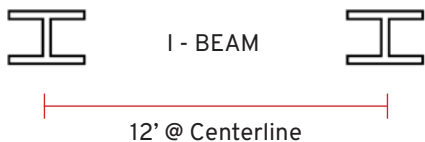
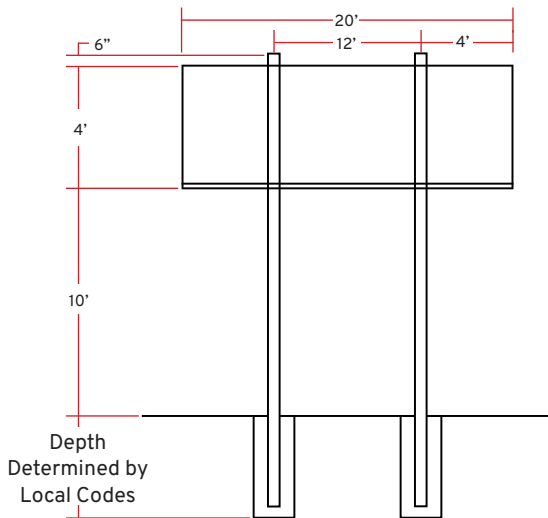

### RE-USING OLD COLUMNS

If you plan to re-use old columns to install your scoreboard, please take measurements of your columns and call technical support at 800-411-3136 to discuss further instructions.

**NOTE: The location of the disconnect switch after installation shall comply with Article 600 of the National Electric Code.**



## MOUNTING THE SCOREBOARD

### IMPORTANT:

\*TO ASSEMBLE, LIFT, AND INSTALL USING THIS METHOD, YOUR LIFTING DEVICE MUST BE CAPABLE OF LIFTING IN EXCESS OF 2000 LBS. IF YOU DON'T HAVE ACCESS TO THAT TYPE OF LIFTING DEVICE, YOU MAY NEED TO ASSEMBLE/ LIFT/INSTALL IN SECTIONS.

#### 1 /

After unpacking the scoreboard, arrange the panels in order A – E from RIGHT to LEFT, face down, with the top away from the mounting poles or I beams. Keep the panels aligned at the top and against each other, making sure not to pinch cables that may be hanging outside of each cabinet.

#### 2 /

Join the cabinets using the 3.5" X 20' mounting angle, making one assembly.

#### 3 /

Install crossover nipples between cabinets. Failure to install crossover nipples will void the warranty. Connect wiring in each of these sections.

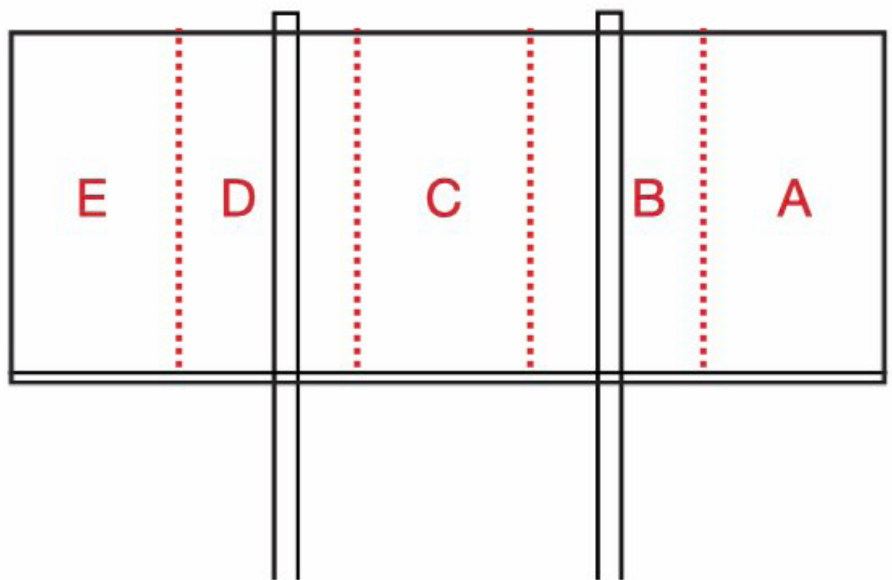
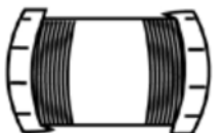

BACK OF SCOREBOARD

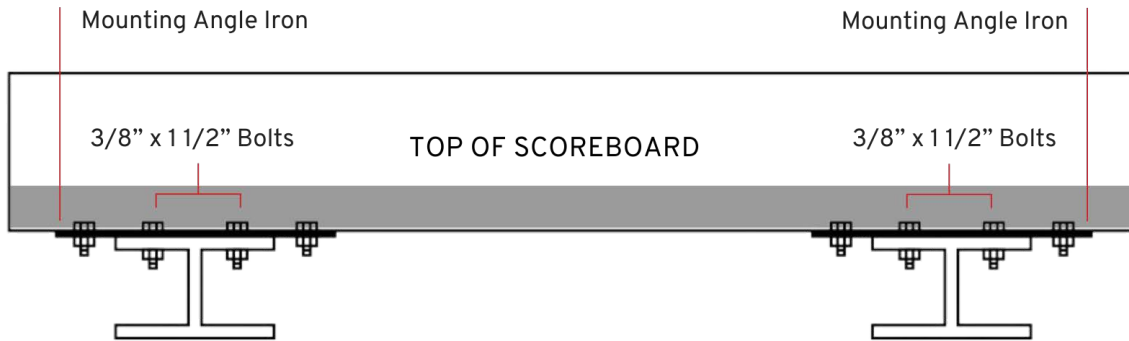

4 /

Connect ALL crossover cables between cabinets as in the “Cable Connections” image below, making sure the red stripe on the edge of the ribbon cables are aligned when connected. The power harnesses are male/female and cannot be connected incorrectly.

5 /

Lift the assembly from the top angle irons to a vertical position, still resting on the ground and install the top sponsor panel if included in the installation. (refer to page 13 for sponsor panel instructions)

6 /

Lift the scoreboard up high enough to install the bottom sponsor panel if included in the installation.

7 /

Raise the scoreboard to the mounting poles or I Beams and at the proper height, use a clamp at one pole or I beam to hold that corner in place.

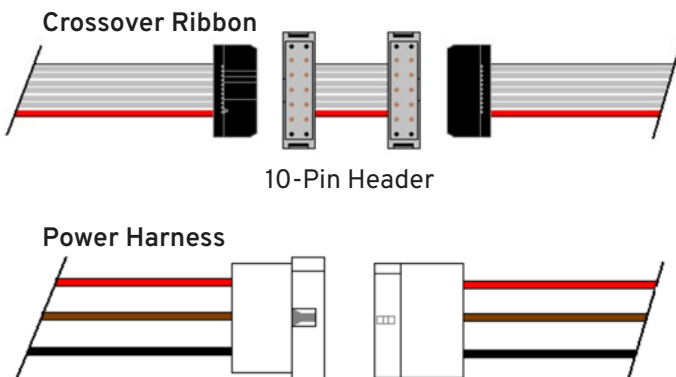

8 /

Using a level in the top channel of the scoreboard, slowly raise the scoreboard to level it and clamp to the other end mounting pole or I Beam.

9 /

Weld or bolt the mounting angle to the poles or I Beams you are clamped to and follow the same procedure at the bottom of the scoreboard, clamp and weld or bolt. Follow by welding or bolting the angle to the center pole or I Beam at the top and bottom. It may be necessary to use clamps here as well.

10 /

If any other options were purchased, install them by referring to their specific installation instructions.



## INSTALLING SPONSOR PANELS

### NOTE:

DETERMINE NUMBER OF SPONSOR PANELS BEING INSTALLED AND THEIR LOCATION.

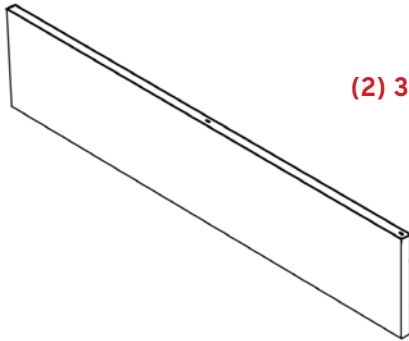

(2) 31" x 10" Sections

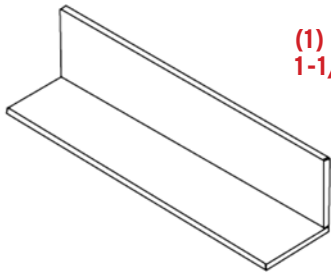

(1) 20' Long 1-1/2" x 1-1/2" Mounting Angle

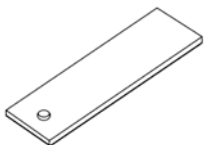

(8) 2" x 8" Mounting Brackets



(8) 3/8-16 x 3/4" Bolts



(8) 3/8-16 Hex Nuts



(22) #8 x 1/2" Tek Screws



(16) M3/8" Flat Washers

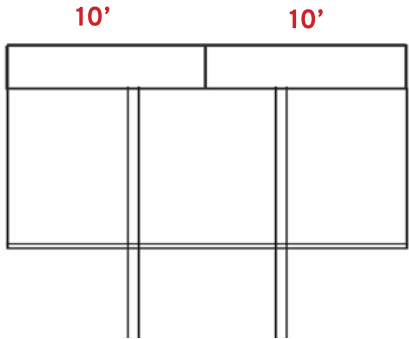
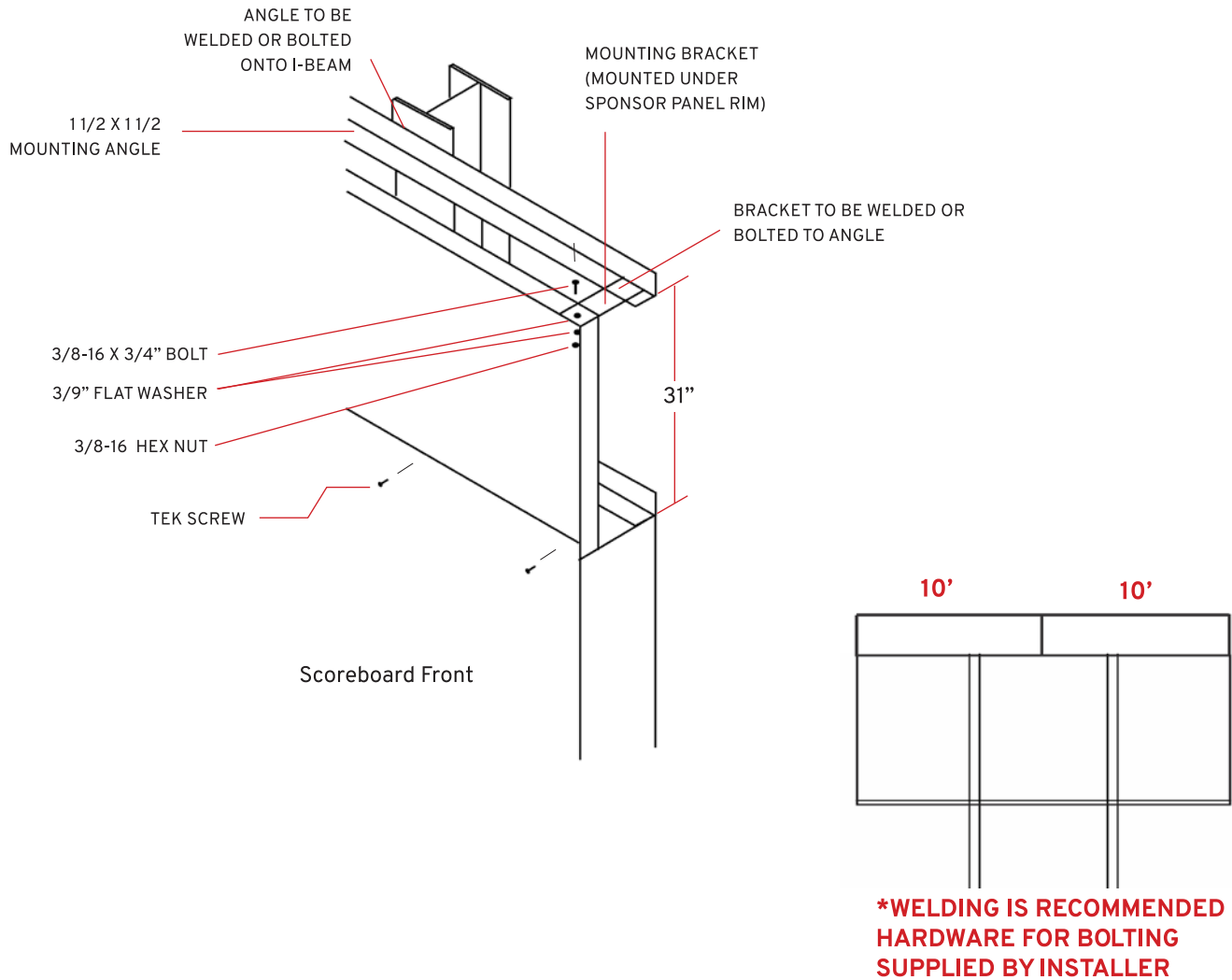

**\*WELDING IS RECOMMENDED  
HARDWARE FOR BOLTING  
SUPPLIED BY INSTALLER**

**1 /**

Attach the 20' mounting angles to the scoreboards' poles/I-beams with the bottom of the angle 31" above the top of the scoreboard for a top mounted installation. Attach them 31" below the bottom of the scoreboard for a bottom-mounted installation as illustrated. The angles should be flush with the left and right ends of the 20' long scoreboard. Welding is recommended. If the angle is bolted to the poles/I-beams, all mounting hardware is the responsibility of the installer.

**2 /**

Before the sponsor panel sections are lifted into place, attach four 8" mounting brackets to each 10' panel section and four 8" mounting brackets to the 8' panel section using the supplied 3/8-16 X 3/4" bolts, 3/8" flat washers, and 3/8" hex nuts. The brackets fit inside the panel. The top (for top-mounted installations) or the bottom (for bottom-mounted installations) of each panel is pre-drilled for the brackets.

**NOTE: A flat washer should be used both on top and on bottom of the panel, as illustrated above**

**3 /**

Lift the first sponsor panel section into place with the panel resting on top of the scoreboard for top-mounted installations or against the bottom of the scoreboard for bottom-mounted installations, with the face of the panel flat against the scoreboards' front 1-1/2" tall flange, as shown above.

**5 /**

Repeat steps 3 & 4 to mount the remaining sponsor panel sections.

**4 /**

Weld or bolt the 8" mounting brackets (already attached to the sponsor panel section) to the mounting angle, as shown below. Welding is recommended. If the mounting brackets are bolted to the mounting angle all mounting hardware is the responsibility of the installer.

**6 /**

Install the tek screws through the scoreboards front 1-1/2" -tall flange and into the sponsor panel face spaced every foot.



## TESTING THE INSTALLED SYSTEM

Please refer to the OPERATORS MANUAL for startup instructions.

**AFTER INSTALLATION IS COMPLETE, HAVE THE INSTALLER TEST THE SCOREBOARD BY FOLLOWING THE STEPS BELOW:**

**1 /**

While holding down the OPTIONS button, turn the wireless controller on

**2 /**

The screen will display "Select Diag Mode." Press the down arrow once to scroll to "Digit Test." Press ENTER.

**3 /**

The screen will display "Segment Test" and "Segments Off". Press the down arrow once to display "Segments On". When all segments are on, all digits should display "8"

**4 /**

Press the down arrow again to display "Digits Count". All digits should continuously count from 0-9

**5 /**

If all digits turn on and count, the installer can then turn off the wireless controller.

**Congratulations!**

**You've successfully installed your Varsity Scoreboard!**

If any problems arise, please have the installer call Varsity Scoreboards Customer Service at 800-411-3136 while the installer is still present at the scoreboard.

**VARSIITY** /   
**SCOREBOARDS** /